

PORTAGE & MAIN OUTDOOR WATER FURNACE Optimizer 250 Wood Gasification Unit



Installation and Operation Manual

Please save these instructions and refer to them for safe and efficient performance

Table of Contents

	Page
Letter to Customer.....	3
The P & M Outdoor Water Furnace System.....	4
Location	4
Placement.....	5
Chimney.....	5
Clearances	5
Pipe Trench.....	5
Water Fill-Up	6
Corrosion Control.....	6
Electrical Connections	6
Start-Up	7
Setting	7
Operation Instructions	8
Saving Tips	8
Corrosion Control.....	9
Creosote Control.....	9
Ash Disposal.....	9
Safety Warnings	9
Maintenance/Fan & Damper Assembly	9-10
Connection to Heating System.....	11
Schematic # 1	12
Schematic # 2.....	13
Schematic # 3.....	14
Schematic # 4	15
Wiring Diagram	16
Control Functions.....	16-19
Trouble Shooting	20
Warranty Information	21
Records	23-24

PORTAGE & MAIN OPTIMIZER 250 WATER FURNACE

Manufactured by
Piney Manufacturing Ltd.
Box 130, Piney
R0A 1K0, MB
Canada

Thank you for purchasing an Optimizer Water Furnace which has been tested and approved by the Canadian Standard Association.

Please observe the instructions contained in this Manual and affixed to the unit to enjoy the full benefits of heating your home, other buildings and your domestic water in a safe and efficient way. We also recommend that you consult and comply with your local electrical, plumbing and fire codes, which supersede these instructions. We have also included some maintenance procedures and tips that will ensure efficient, economic and trouble-free operation.

For more information regarding the installation, operation and maintenance of this unit, please contact us, Heat Smart Plus or your nearest dealer.

Piney Manufacturing Ltd.

THE OPTIMIZER 250 OUTDOOR WATER FURNACE

The Optimizer 250 outdoor (or indoor*) water furnace is safe and highly efficient, conveniently installed outside your house to give you the comfort you desire all year round using the oldest and most environmentally friendly fuel of all: WOOD. (* inside outdoor buildings such as barn, shop, shed etc.)

This unique system has a fire pot and a multiple pass heat exchanger which are totally immersed in a water jacket that keeps its components from overheating and warping. The front door is insulated and built of heavy gauge material to eliminate warping. The boiler tube style heat exchanger is designed to extract useful heat from the exhaust flue which is virtually smoke free before they exit through the insulated stainless steel chimney.

The water temperature is maintained at the desired level by means of Johnson automatic controls. The heated water is pumped to the house and the other buildings by means of individual circulating pumps through an individual underground loop for each building or application. Always use the best insulated and water proof pipe.

The heating loop will provide the required amount of heat to your house or building, regardless of your existing heating systems as described later on. You can also add a water-to-water heat exchanger to your system to provide you with all your domestic hot water requirements to increase your fuel savings considerably.

The Optimizer 250 Water Furnace is equipped with a fan for forced combustion air to modulate the burning rate as required, and with safety instruments that would prevent the water from overheating or boiling.

Please follow the instructions contained in this Manual to enjoy the comforts of heating with wood in a safe manner.

LOCATION

The ideal location for the Optimizer Water Furnace should be:

1. Outside your residence for safety and lower insurance rates.
2. In a separate structure such as your garage, shop or shed.
3. Away from storage of wood, chemicals and other flammable materials.
4. No closer than 50 feet from existing residence and other buildings.
5. Downstream of prevailing winds relative to main residence.
6. On the side of pipe entry to residence.
7. Proper clearance distance to combustibles.

RECOMMENDATION

For extra safety, we recommend a hot water circulation loop that will dissipate at least 10% (ten percent) of the estimated heat output of the water furnace in the event that circulation is reduced because of electrical power failure. This loop should be such that it can only be made inoperative by a deliberate manual action. The minimum pipe to be used should be 18mm (.75 inch) in diameter.

PLACEMENT

We recommend a concrete or cement (noncombustible) slab for placing the Optimizer Water Furnace. The slab should be at least four (4) inches thick, sixty two (55) inches wide and sixty (70) inches long with a well packed sub-base. The unit weighs 3030 pounds plus 1980 pounds of water.

CHIMNEY

We recommend the use of insulated stainless steel pipe as a stack to minimize creosote formation. A six (6) inch pipe is used for the Optimizer 250. The stack should extend at least four (4) feet above the building where the Boiler is located. Use a proper approved chimney for indoor installs.

CLEARANCES

The Outdoor (indoor) Water Furnace should be placed in a location where it can always get a significant amount of fresh air. This is important for the water furnace to operate efficiently, and to have good combustion.

The minimum installation clearances to combustible materials are:

- Back & Sides: Forty eight(48) inches(122 cm)
- Front & Sides: Forty-eight (48) inches(122 cm)
- Top Eighteen (18) inches(46 cm)
- Flue Pipe: Eighteen (18) inches(46 cm)

Note: Adequate space should also be left around the outdoor water furnace in addition to the required clearances for servicing and maintenance.

PIPE TRENCH

- Pre-insulated pipes such as Urecon Dual Pex Flex, properly sized for circulation requirements, are recommended to convey the hot water from the outdoor water furnace to each building. The piping should be laid in a flat trench eighteen (18) inches to thirty six (36) inches deep. If high water table is encountered, the trench may be shallower, traffic permitting. It is to your advantage to be down deeper at the boiler/furnace especially as it makes the bend easier.
- Use water tight pipe insulation is recommended as all Styrofoam will absorb water to the point it becomes very poor insulation. Only use in high dry well drained areas if using at all.
- ALL PLUMBING MUST BE DONE ACCORDING TO APPLICABLE LOCAL CODES.

WATER FILL-UP

- After installing the Optimizer Water Furnace in place and connecting to it the supply and return pipe(s) to and from the various buildings to be heated, IN ACCORDANCE WITH APPLICABLE LOCAL CODES, the heating installation is ready to be filled with water.
- Before filling the Optimizer Water Furnace with water, make sure all valves are in "closed" position, and unused supply and return outlets in the control panel of the outdoor water furnace are tightly capped or valves installed for future use.
- A permanent water supply to the Outdoor Water Furnace is recommended by tapping into the water mains and connecting it to the top of the Outdoor Water Furnace through a manually operated shut-off valve. Use only good quality water. Do not use water with iron, minerals, or hard water. Do not use reverse osmosis water. Rain water is usually the best.
- Add water until the entire heating installation is filled and the water level gauge on top of the outdoor water furnace indicates almost full. (This will allow for water expansion.)
- Before starting the outdoor water furnace make sure the entire heating installation is properly vented to facilitate the circulation of water in the heating loop(s).
- Ensure water trap and discharge pipe are properly installed and unobstructed to release any pressure build-up in the outdoor water furnace.

CORROSION CONTROL

- To control corrosion in the Portage & Main Outdoor Water Furnace we recommend the following:
 1. Always use certified boiler treatment. Submit water sample for testing annual through your dealer. Keep your records.
 2. Always maintain the proper water level.
 3. Add a commercially available antifreeze solution to the water in the order of thirty (30) per cent, during the initial water fill-up. Optional.
 4. When adding large make-up water quantities to compensate for evaporation and to maintain proper water level, use the same ratio of antifreeze solution to the make-up water. For smaller make-up water quantities, no antifreeze solution is required.
 5. If sedimentation occurs after the initial few weeks, the water should be treated chemically to adjust its pH level. Consult your dealer for water analysis and treatment.
 6. Keep ashes to minimal. Do not burn garbage.

ELECTRICAL CONNECTIONS

- The Optimizer 250 Water Furnace is factory-wired and is ready for connecting it to an AC/120V/60 Hertz supply
- ALL ELECTRICAL CONNECTIONS SHOULD BE WIRED ACCORDING TO APPLICABLE LOCAL CODES.
- Make sure outdoor water furnace (and metallic water lines, if used) is well grounded to avoid pitting in the water jacket.

STARTING-UP

- Before starting-up observe the SAFETY WARNINGS contained in this Manual.
- Make sure the Outdoor Water Furnace, circulating loops and existing heat exchangers or baseboard heaters are full of water and properly vented.
- Ensure the circulating pump(s) is properly installed according to manufacturer's instructions. Failure to do so could void the Warranty.
- Load the outdoor water furnace with wood only to fill half of the firepot. Use kindling wood to start the fire. DO NOT USE ANY FLAMMABLE LIQUIDS TO START THE FIRE.
- Always turn the power off before loading the appliance with wood or opening the firing door. Keep firing and gasification chamber doors tightly closed at all times for safety when outdoor water furnace is in use. Always open doors slowly.
- Inspect the chimney and make sure it is clear from any obstructions.
- Set the aquastat to the highest temperature setting on the dial (180 °F) as described under SETTING. When the water temperature reaches this set point, the control will turn the combustion fan off to close the air damper in the back of the outdoor water furnace.
- When the combustion fan is shut off turn the setting dial down to a range of 160 ° to 180 °F. Now turn the circulating pump(s) on and leave it on at all times.

- Before leaving the Outdoor Water Furnace location, make sure that:
 1. The water level is adequate.
 2. The wood loading door is tightly closed.
 3. All doors are tightly closed.
 4. The area around the outdoor water furnace is clear from any combustible materials.

SETTING

The Portage & Main Outdoor Water Furnace is equipped with a digital display immersion type aquastat controller which operates in response to water temperature changes.

To set the temperature at the desired level, go to page 19 of this manual.

OPERATING INSTRUCTIONS

1. The Optimizer 250 Water Furnace may be connected to an existing boiler system. Burn natural wood only. Make sure the wood is dry and split if required to dry. Cover wood to protect from fall rains and snow.
2. To avoid damage load wood carefully. Always shut off power before opening firing door or loading the appliance with wood. Unlatch the firing door to the first catch, allow 5 seconds for smoke to dissipate before opening door fully. There is also a switch for the blower fan in the front of the furnace which should be turned off before opening the firepot door.
3. Do not use chemical substances or liquid fuels to start or enhance the fire.
4. Do not burn garbage, liquid fuels, engine oil, naphtha or other flammable materials, which may cause a fire or an explosion or cause corrosion.
5. The Optimizer 250 has 2 air flow adjusting valves located in the back of the unit inside the control panel. The air box where the blower fan is mounted on has two handles on it, the top one is the primary air which supplies air to the firebox, the bottom one is the secondary air which supplies air to the exhaust after it leaves the fire box these two valves need to be adjusted accurately so that the gasifying process is correct.
6. To adjust the air flow it seems that the top valve (primary air) can be open 4 to 5 turns, and the bottom (secondary air) is only 3 to 4 turns. To insure a good setting you can look at the flame coming out of the fire pot into the reaction chamber, at max burn you should see a very intense flame like a blow torch exiting the fire pot.(For this process to work efficiently the wood has to be dry and of smaller diameter (3 to 4 inches). Experience will show you the best size of wood. Smaller dry wood help build up a coal bed.
7. Clean the heat exchanger regularly to remove accumulated ash. Flue pipe and chimney need to be cleaned periodically.
8. Clean the Outdoor Water Furnace and cap the chimney at the end of each heating season to minimize corrosion during summer months.
9. Always maintain the Outdoor Water Furnace, flue pipe and chimney in good condition.
10. Do not load the Outdoor Water Furnace with wood during an electrical power failure. Do not leave fire door open.
11. For safety do not store any fuel or combustible materials within the installation clearances of the outdoor water furnace.
12. Keep firing, gasification and heat exchanger doors tightly closed at all times for safety.
13. Always keep 4 to 5 inches of ash (hot coals) in the fire box; the furnace works best when this ash bed is kept. Keep the ash area below the firepot in the reaction chamber clean and free from ash to allow maximum air to exit the firepot.

SAVING TIPS

- Keep the circulating pump(s) on all the time to maintain a comfortable environment and avoid temperature swings and settling of suspended matter in the water. For summer the pumps may be left running to minimize pump seizure or they may be generally turn off and occasionally turned on.
- Maintain a regular wood-loading schedule to keep the Outdoor Water Furnace operating under steady-state conditions
- Turn the circulating pump(s) on occasionally during summer to minimize pump seizure.

CORROSION CONTROL

To control corrosion of the Outdoor Water Furnace, we recommend the following:

1. Use proper certified boiler treatment as recommended by the furnace manufacturer.
2. Use antifreeze as described under Water Fill-Up.
3. Always maintain adequate water level. If level drops occasionally, check for leaks or boiling of boiling water and refer to the Troubleshooting Section.
4. Make sure the Outdoor Water Furnace is properly grounded.
5. Remove ashes when Outdoor Water Furnace is not used.
6. Cover the chimney during off-season to prevent rainwater from entering the firepot.
7. Clean the firepot during the off-season.
8. Clean the heat exchanger with the cleaning tool provided with the Outdoor Water Furnace, through the cleaning door located above the wood-loading door.

CREOSOTE CONTROL

- The Optimizer when operated properly will have little or no creosote in the heat exchanger tubes, all that should accumulate there is very light ash or dust. If creosote does form in the heat exchanger tubes then the gasification process is not working properly.
- Accumulations of creosote when ignited may result in chimney fires.
- We recommend inspecting the chimney once a month during the heating season and removal of creosote linings to reduce chimney fire hazards.
- Green or unseasoned wet wood or wood that is not covered with a roof will likely be higher than 25% moisture. This wood will cause creosote to form.

Leaky door gaskets will also cause creosote to build up.

ASH DISPOSAL

- Ashes should be removed from the Outdoor Water Furnace regularly or they will block the flow of air exiting the fire box.
- Ashes should be stored in metal containers with tight lids and kept in an area free of combustible materials until finally disposed.
- Do not dispose of ashes while embers are still hot.
- Check local by-laws for ash disposal. Wood ash can be used to reduce soil acidity or as a fertilizer for the garden.

SAFETY WARNINGS

- **Never leave children un-attended near the outdoor water furnace/boiler.**
- **Never add water when outdoor water furnace temperature is close to 212 °f as it may result in steam flashing.**
- **Never perform any service or maintenance work before water temperature drops below 100 °F.**
- DO NOT store combustible materials or liquids near the Outdoor Water Furnace.
- DO NOT burn any materials other than natural wood.
- DO NOT use flammable liquids or materials to start or to enhance the fire.
- DO NOT leave wood loading door open or unlatched.

- DO NOT open the loading door too quickly to avoid blowbacks which could cause severe burns.
- ALWAYS check water level, aquastat and damper setting for a proper and safe operation.
- Lock doors with your own locks as required.
- Never allow unauthorized opening, filling or servicing of the furnace
- DO NOT touch any part on the front of the Outdoor Water Furnace, which are not insulated to avoid skin burns.
- ALWAYS store ashes in tightly covered metal containers away from combustible materials.
- It is not designed to be used as an incinerator.

MAINTENANCE

- Optimizer 250 Outdoor Water Furnace is designed to operate for many years with the least amount of maintenance. Good housekeeping practices and observance of the instructions contained in this Manual would assist you in maintaining the outdoor water furnace in good and safe working conditions.
- ALWAYS SHUT OFF THE POWER SUPPLY prior to performing any service or maintenance work.
- Refer to the SAETY WARNINGS and OPERATING INSTRUCTIONS prior to performing any or maintenance work.
- If circulating pump(s) is seized due to a prolonged shutdown, removed the screw in the center of the motor and turn the motor shaft with a screwdriver to loosen it.

The Primary and secondary air have to be manually adjusted to the desired amount of air required. This is done simply by turning the handles (as previously described on pages 8 and 9) on the primary and secondary air flow adjuster. This blower fan assembly should not be altered in any way for increased fire.

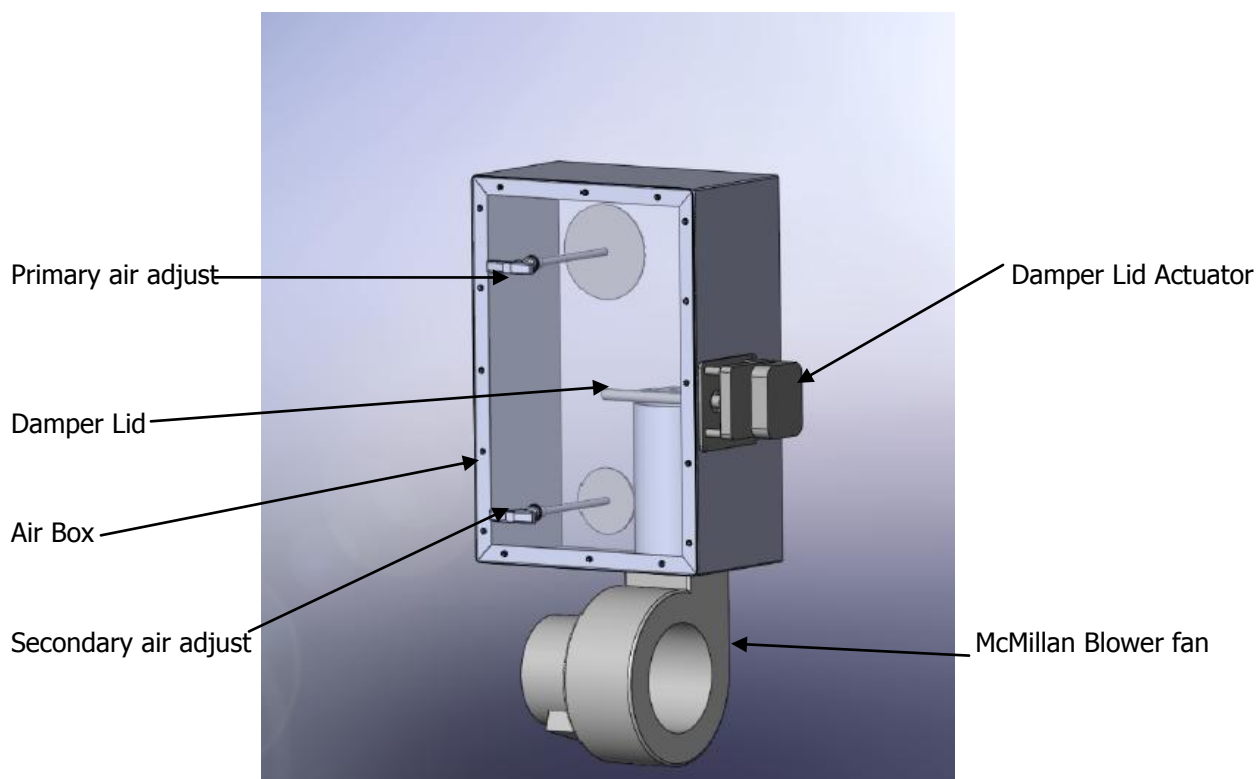

CONNECTION TO HEATING SYSTEMS

The P & M Heating System is versatile and can be connected to any existing or new heating system and/or domestic water system as described below. **The corresponding schematics are provided as a guideline only.** ALL CONNECTIONS MUST BE EXECUTED ACCORDING TO LOCAL PLUMBING AND ELECTRICAL CODES.

1. EXISTING FORCED AIR SYSTEM

All you need is to install a water-to-air heat exchanger in your existing furnace plenum (on the supply side) to keep your house as comfortable as you desire using a separate thermostat. Your existing furnace would be used as a back up when required. (Refer to Schematic #1)

2. EXISTING WATER BASEBOARD SYSTEM

A water-to-water heat exchanger will be required to replace your existing boiler and provide you with all the comfort you require. Your existing boiler would be used as a back up when required. (Refer to Schematic #2). Another alternative would be to convert your existing system into an "open system" with the assistance of an expert in heating system.

3. DOMESTIC WATER HEATER AND HEATING SYSTEM

You can enjoy more energy savings and running hot water during the heating season by connecting your domestic water heater to the Portage & Main Heating System through a sidearm water heater. (Refer to Schematic #4). We would caution you, however, that creosote may increase during summer due to lowered heat demand. **But** if additional heat could be used elsewhere, then creosote formation would be reduced.

4. HOT TUB, POOL HEATING use shell tube and shell heat exchanger.

CONNECTING THE P&M SYSTEM

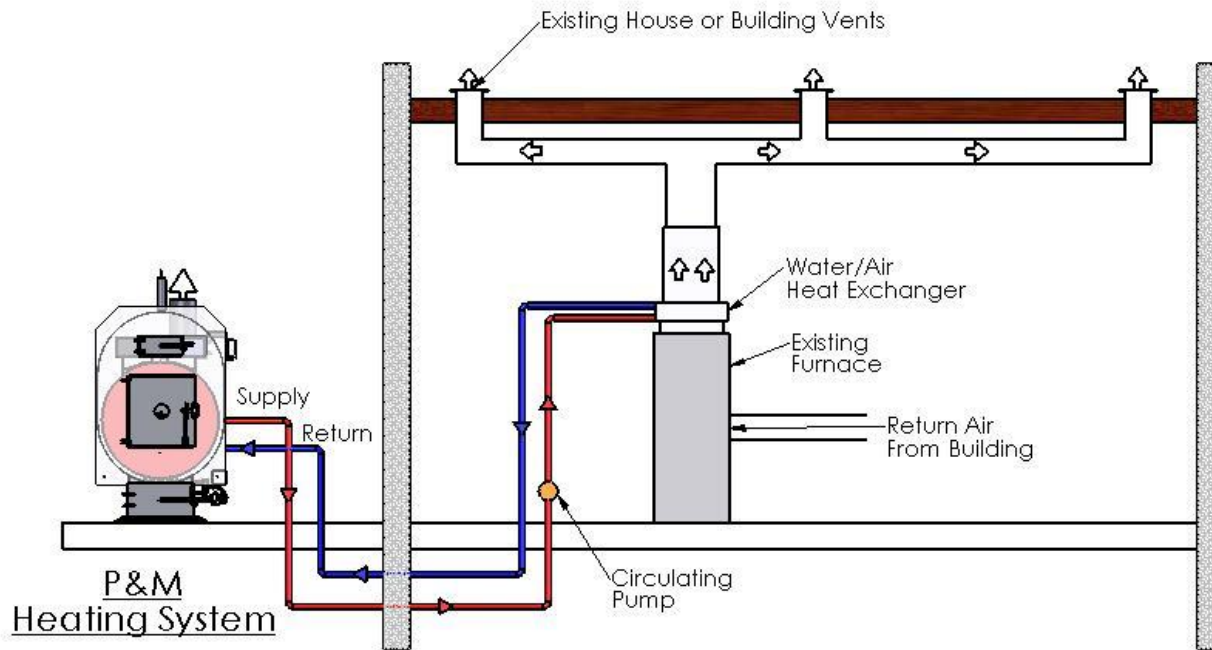

CONNECTING TO AN EXISTING FORCED AIR SYSTEM

SCHEMATIC #1 - Schematic Drawing for Illustration Purposes Only

CONNECTING THE P&M SYSTEM

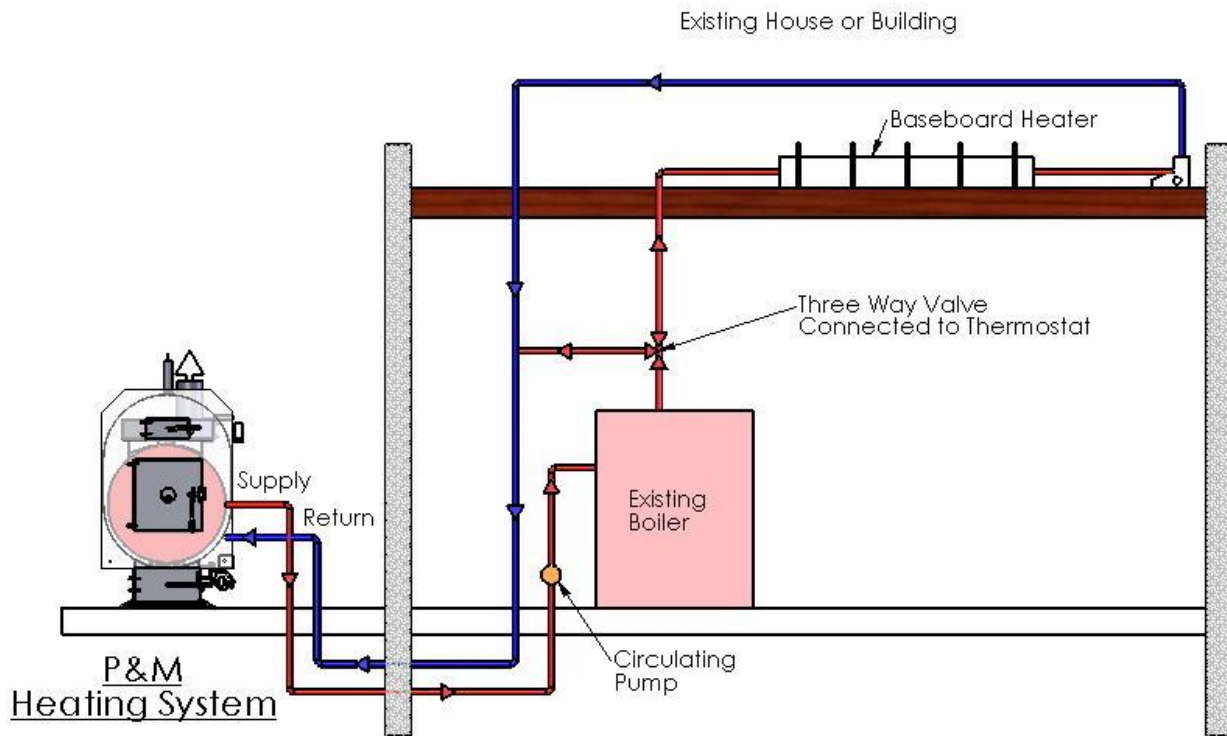

CONNECTING TO AN EXISTING BOILER / BASEBOARD SYSTEM

SCHEMATIC #2 - Schematic Drawing for Illustration Purposes Only

CONNECTING THE P&M SYSTEM

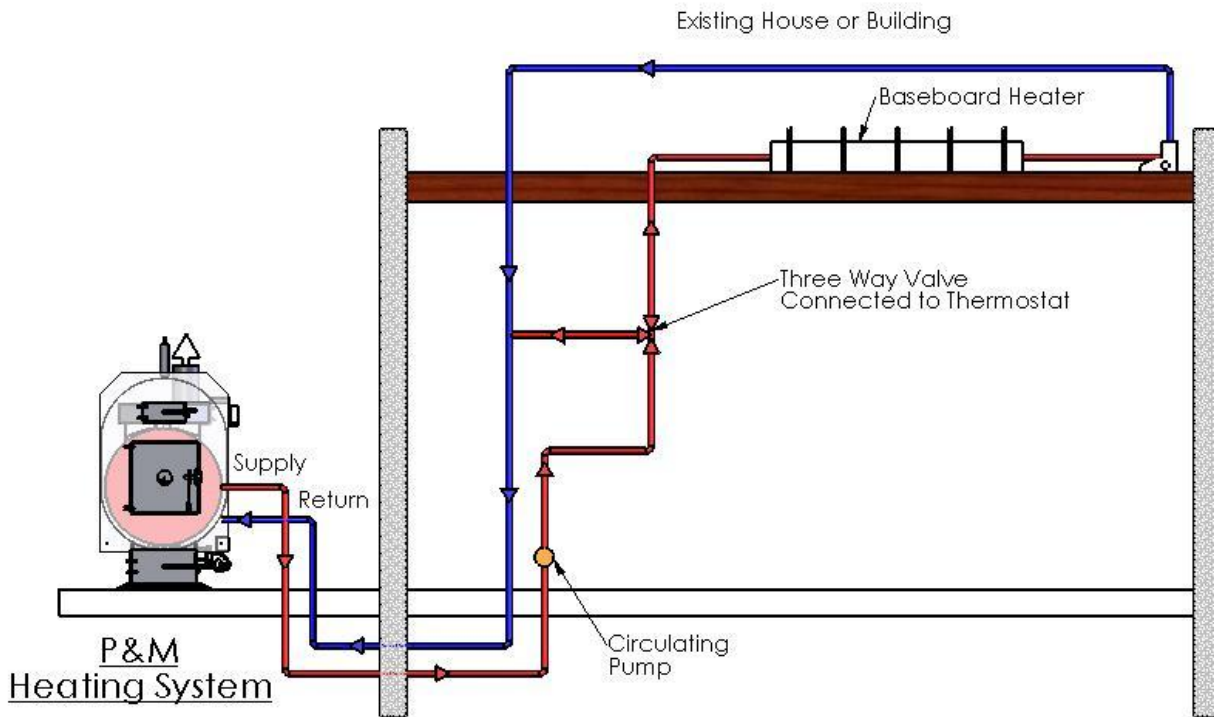

CONNECTING TO A NEW BASEBOARD SYSTEM

SCHEMATIC #3 - Schematic Drawing for Illustration Purposes Only

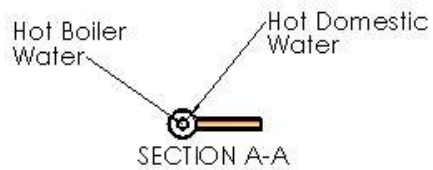
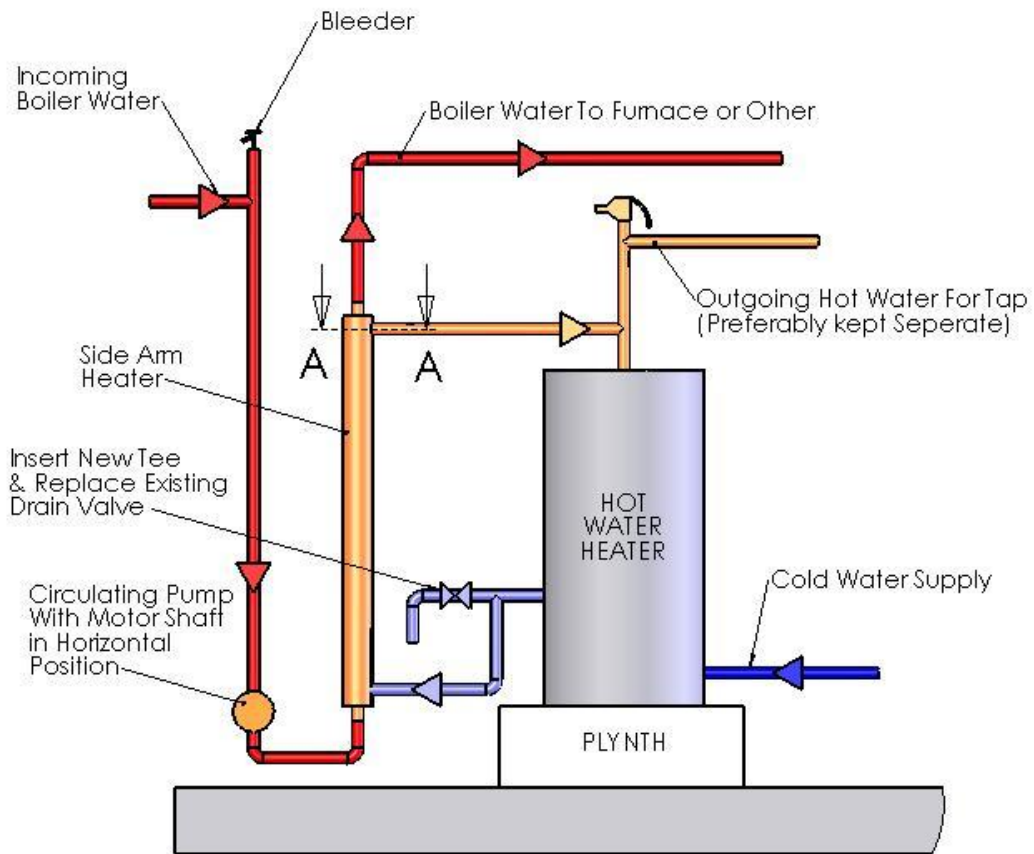

NOTE!

It is suggested that the hot water heater be raised on a plynth as shown, to give max. length of side arm heater. (5 feet long if possible) Top outlet should be as close as possible to the top of the water heater

SCHMATIC #4 - CONNECTING SIDE ARM HEATER TO DOMESTIC WATER TANK

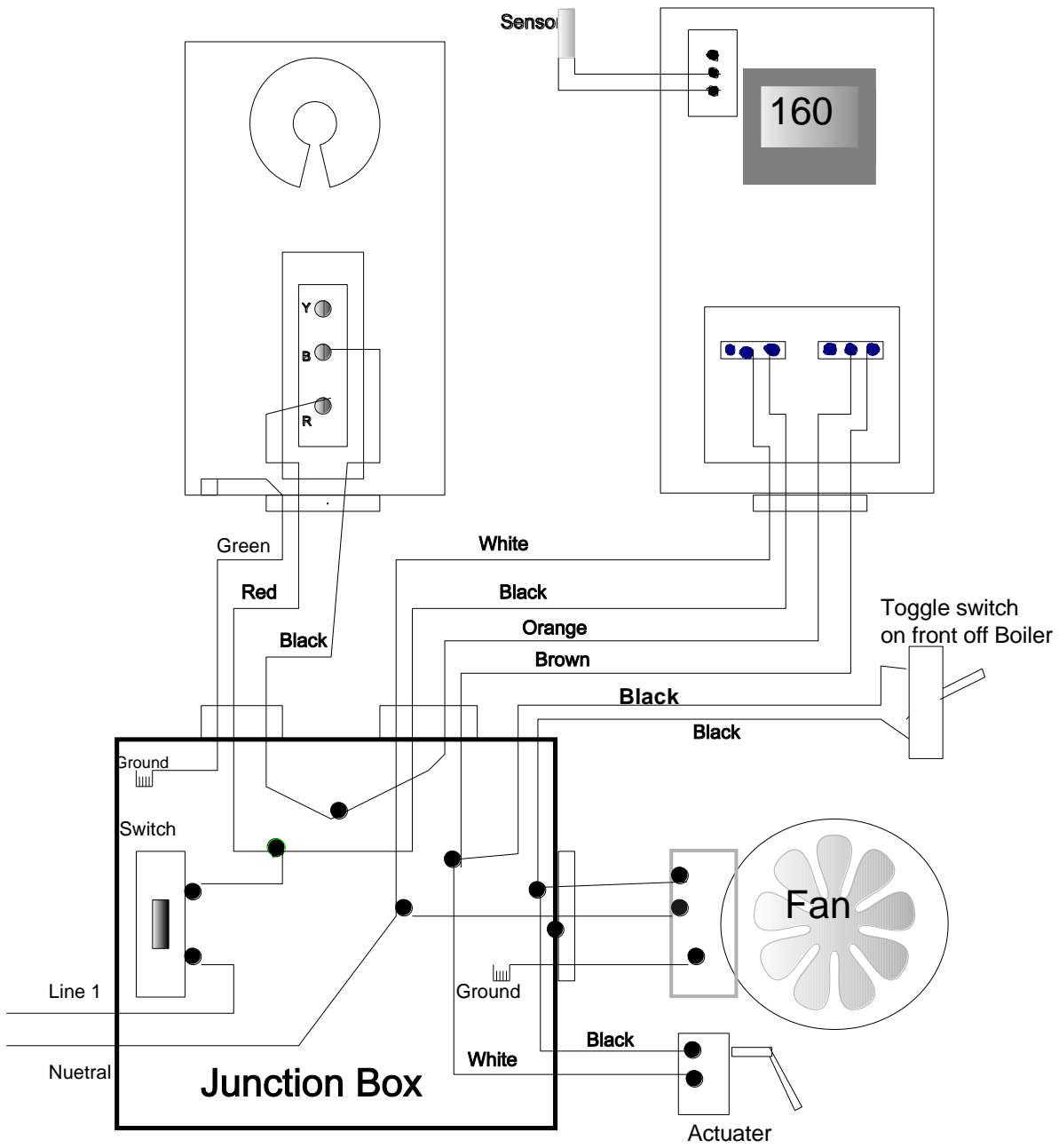

Wiring Diagram

The A419 control functions

Set point (SP) establishes the temperature value at which the equipment is switched on or off, depending on the user selected mode of operation. Set point range is -30 to 212°F or -34 to 100°C (in 1-degree increments).

If Set point mode is set to cut-in, set point is the temperature value at which the control closes the Normally Open (N.O.) contacts. If Set point mode is set to cutout, set point is the temperature at which the N.O. contacts open.

Differential (DIF) established the difference in temperature between the cut-in value and cutout value. The differential is set relative to Set point and may be set from 1 to 30 F° or -17 to -1 C° (in 1 – degree increments).

Anti-Short Cycle Delay (ASD) established the minimum time that the outplay relay remains de-energized before the next on-cycle. The **ASD** does not allow the output relay to re-energize until the programmed time delay has elapsed. The delay is activated when the control is first turned on and every time an on-cycle ends. When the delay is activated, the LCD alternately flashed the sensor temperature and **ASD**. The anti-short Cycle Delay range is 0 to 12 minutes (in 1-minute increments).

Sensor Failure Operation (SF) establishes how the A419 control's output-relay operates the equipment in the event of a sensor or sensor wiring failure. The user may select to run the equipment continuously or to shut it down. When the control detects a sensor circuit failure, the LCD flashes SF alternately with OP (if the sensor circuit is open), or **SH** (If the sensor circuit is shorted). Before indicating a failure, the control implements a 1-minute delay, which allows verification of failure condition and avoids nuisance failure indications.

Temperature Offset (OFS) establishes a set secondary **Set point** and **Differential** values that may be invoked to control an application when a circuit is closed between the binary input (**BIN**) and common (**COM**) terminals (and **BIN** appears on the display). See Figure 3. Offset range is 0 to 50F° or C° (in 1-degree increments). A typical application might use a switching time clock to invoke night-setback temperature settings.

IMPORTANT: Make sure the Touchpad Lock jumper is installed (unlocked) before attempting to adjust the A419 control functions.

Changing the A419 Control Temperature Units

The A419 control is factory set to display Fahrenheit temperature. To change to Celsius, press **Up** and **Down** (arrows) simultaneously. Press them again to display Fahrenheit units. Verify that the control is displaying the desired temperature units before setting the Set point.

Setting the A419 Control Set point Value

To view and adjust Set point, follow these steps:

1. Press and hold MENU (about 2 seconds) until the display flashes SP.
2. Press MENU again to display the existing set point value.
3. Press Up or Down (arrows) to change the set point value.
4. Press MENU again to save the new value. The display returns to the sensed temperature.

Note: If no setup entry is made for 30 seconds, the control reverts to the (normal) temperature display.

IMPORTANT: If MENU is not pressed after changing the set point value, the control reverts the previously programmed set point value.

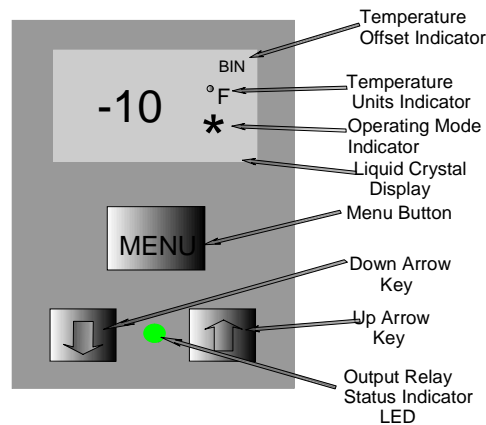

Figure 6: Liquid Crystal Display, Touchpad, and LED Indicator

Settings on the Other A419 Control Functions

To set the Differential, Anti-short Cycle Delay, Temperature Offset, or Sensor failure operation, use the following method.

1. Press and hold Menu until the display changes to flashing SP. (This takes about 2 seconds.)
2. Press Up or Down (arrows) repeatedly until the desired function is displayed. (See Table 3.)
3. Press Menu to display the functions current value.
4. Press Up or Down (arrows) until the desired value is displayed.
5. Press MENU to save the new value. The display returns to the sensor temperature.

IMPORTANT: If MENU is not pressed after changing the settings, the new settings are no saved and the control reverts to the previously programmed setting values.

NOTE: If no setup entry is made for 30 seconds, the control reverts to the (normal) temperature display.

NOTE: Any saved A419 control settings are non-volatile and remain in the control's memory during power interruptions.

IMPORTANT: Do not Set point and Differential values which (when totaled) fall out of A419 control's Set point range (-30 to 212 °F [-34 to 100°C]). The control will not function properly if Cut-in or Cutout values are outside of the control's Set point range.

Checkout

Before applying power, make sure installation and wire connections are correct for your application. Then power, operate and observe the system and A419 control for at least three complete operating cycles before leaving the installation.

Table 3: Display Symbols, control Function, Ranges, Unites, Values, and Factory Settings

Display Symbol	Control Function	Range – Units/Value	Factory Set Value
SP	Set point*	-30 to 212 - °F (-34 to 100 - °C)	30
DIF	Differential*	1 to 30 – (F° or C° in 1-degree increments)	5
ASD	Anti-short cycle Delay	0 to 12 – (in 1-minute increments)	1
OFS	Temperature Offset	0 to 50 (F° or C° in 1-degree increments)	0
SF	Sensor Failure Operation	(No range) – 0 = output relay de-energized 1= output relay energized	1
F or C	Temperature Units	(No range) - F° or C°	F°
BIN	Temperature Offset Indicator	(No range) – BIN is displayed and the A419 control operates on the secondary set points when the circuit between the BIN and COM terminals is closed.	N/A
Snowflake or flame picture	Cooling or Heating Mode of Operation	(No range) – A Snowflake (Cooling Mode) is displayed when the Jump1 jumper is removed. A Flame (Heating Mode) is displayed when the Jump1 jumper is installed.	Snowflake (Cooling Mode)

*The sum of the Set point and Differential values must be within the Set point range, or the control may not function properly.

Trouble	Possible Cause	Solution
Too Little Heat	<ul style="list-style-type: none"> • Fire is out • Low water level or water leaks • Power failure • Circulating pump failure • Air traps in system • Fan is not running 	<ul style="list-style-type: none"> • Add wood/build fire • Check leaks then ad water • Check electrical circuits • Check pump • Vent System • Inspect fan/replace
Too Much Heat	<ul style="list-style-type: none"> • Draft damper actuator stuck in open position • Air leaking through wood door • Aquastat malfunction • Thermostat inside house malfunction • Ash door not shut tight 	<ul style="list-style-type: none"> • Clean, lube and re-install • Clean metal to metal surface • Check Aquastat • Check Thermostat • Check gasket on ash door
Water Boiling	<ul style="list-style-type: none"> • Fan running constantly • Aquastat malfunction • Wood door open • Damper actuator lid stuck open 	<ul style="list-style-type: none"> • Aquastat malfunction • Check Aquastat • Close door tightly • Clean, lube and re-install
Creosote Buildup	<ul style="list-style-type: none"> • Air leaking though wood door • Chimney not insulated or damaged • Burning high pitch bearing wood such as Pine or Balsam 	<ul style="list-style-type: none"> • Clean metal to metal surfaced • Insulate or repair chimney insulation • Use mix of dry and harder wood such as Poplar, Birch Tamarack, Oak, Elm, Ash, etc.

Portage & Main Outdoor Water Furnace— Wood Gasification Unit-Optimizer 250

Portage and Main Outdoor Water Furnaces are designed for burning wood or authorized fuel only. The burning of any other materials or any modifications of the furnace will void this warranty. The electrical components such as the temperature control, fans, etc., are warranted by their manufacturer for a period of one year or as stated by the manufacturer. All gaskets, seals, etc., are warranted by Piney Manufacturing Ltd. for a period of one year from the date of purchase.

Pre-cast heat treated refractory brick is guaranteed by the manufacturer to be of premium quality and free from defect at the time of shipping. Fire brick will develop hairline cracks when subjected to extreme heat. This will not affect the performance of the furnace. Piney Manufacturing Ltd. gives 2 year warranty on the pre-cast heat treated refractory brick.

Piney Manufacturing Ltd. does not warranty parts damaged by freezing, overheating, pressurization, use of unauthorized fuels or abuse or lack of maintenance. The Portage & Main Outdoor Water Furnace Wood Gasification Unit—Optimizer 250 is designed to be a long lasting simple to operate furnace. Proper care and maintenance as outlined in the manufacturer's maintenance instructions should be followed. The Portage & Main Outdoor Water Furnace must be filled with water that meets recommendations outlined in the Portage & Main Outdoor Water Furnace--Optimizer 250 Manual. Failure of proper maintenance such as maintaining water quality by using the recommended water, addition of chemical as required and annually send in samples of water for free testing, will shorten the life of the outdoor water furnace.

Any furnace which is determined to be defective in material or workmanship within three (3) years and returned to Piney Manufacturing , freight prepaid, will be repaired or replaced at Piney Manufacturing Ltd. option at no charge to you.

In year four (4) through the life of the product, Piney Manufacturing will pay a pro-rated share of any repair or replacement cost. The proportionate charge will be equal to the appropriate percentage of the list price of the product at the time of the warranty claim is made, and will be determined as follows: 4th year 80%; 5th year 70%; 6th year 60% 7th year 50%; 8th year 40%; 9th year 30%; year 10th and beyond 10%. No cash surrender value at any time. Piney Manufacturing Ltd reserves the right to replace or repair the parts at its sole discretion.

In addition to the warranty above, the Piney Manufacturing Ltd. warranty does not cover: Components that are part of the heating system (products), used for installation of the Portage & Main Outdoor Water Furnace Optimizer 250—underground insulated pipe, radiators, heat exchanger that may be part of the part of the heating systems (products); the workmanship of any installer of Portage & Main Outdoor Water Furnace(s).

In addition, this warranty does not assume any liability of any nature for unsatisfactory performance caused by improper installation or operation; any costs for labor for removal and reinstallation of the alleged defective stove or part, transportation to Piney Manufacturing Ltd., if necessary, and any other materials necessary to perform exchange; any products that have a failure or malfunction resulting from improper or negligent operation accident, abuse, freezing, over-heating, poor water quality, misuse, unauthorized alteration or improper repair or maintenance; improper adjustments, control settings, care or maintenance. Information is in the installation manual and other printed/technical information provided with the product or direct from Piney Manufacturing Ltd.

If warranty requires replacement of any part, Piney Manufacturing Ltd. will take responsibility for the actual cost of the replacement part only. No other warranty is expressed or implied. Piney Manufacturing Ltd. is not responsible for the cost of plumbing, replacement of antifreeze, shipping costs or any other indirect cost associated with the replacement of the part.

Outdoor furnaces are not intended to be the only source of heat; therefore, it is recommended that a back-up system be in place to prevent damages caused by lack of heat.

Piney Manufacturing Ltd. is not liable for any accidents which may occur from the operation of the furnace, or damage incurred due to heating system failure. The purchaser assumes all responsibility for the care, maintenance and safe operation of the furnace.

Piney Manufacturing Ltd. specifically disavows any other representation, warranty or liability related to the condition or use of the product.

Any complaints or litigation must be filed in Manitoba, Canada.

To validate this warranty, your registration must be completed within ten (10) days of purchase date and faxed to Piney Manufacturing Ltd. 306-922-1662, with a copy of your sales receipt, showing your date of purchase.

This warranty is non-transferable.

07-01-2010

**Portage and Main Outdoor Water Furnace
Warranty Card for Optimizer 250**

Purchaser's Name: _____

Address: _____

Phone: _____

Model: _____ Serial No. _____

Date of Purchase: _____

Dealer: _____

Address: _____

Dealer's Signature: _____

Date: _____

This warranty card must be completed and returned to Heat Smart Plus by fax to
1-306-922-1662 with a copy of the sales receipt within 20 days of sale date.

"I have read, understood and accept the conditions of this Warranty."

Customers Signature: _____

Date: _____

Records & Notes:

